



TREVALLi

Gynecology
Sets

2025

TREVALLI SURGICAL

Quality is our Prority



3 Oldham Place, Pietermaritzburg



083 555 8643



trevalli@mweb.co.za

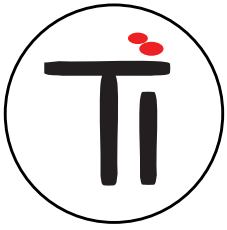

TREVALLI

SET

GYNECOLOGY ABDOMINAL SET

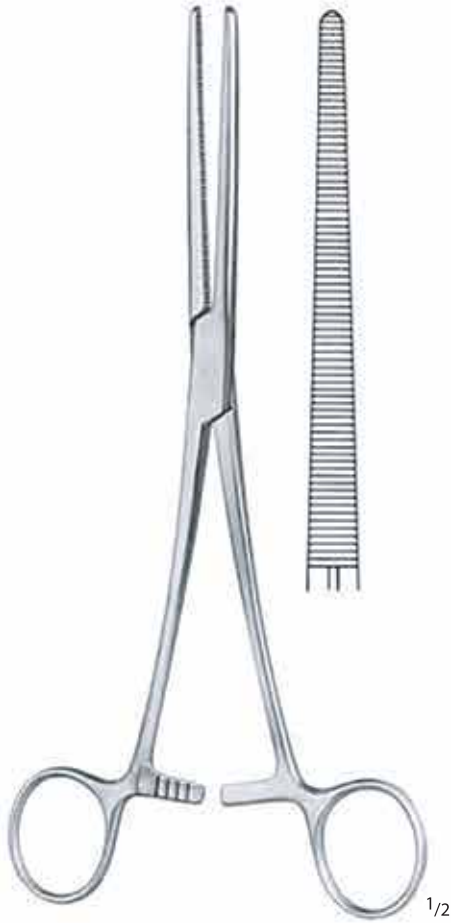
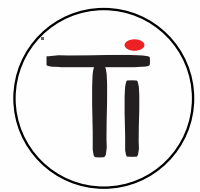

ROCHESTER-PEAN
TS-GI-1001
24.0 cm/9 1/2"



OCHSNER-KOCHER 1:2
TS-GI-1002
24.0 cm/9 1/2"



KOCHER 1:2 - DELICATE
TS-GI-1003
14.0 cm/5 1/2"

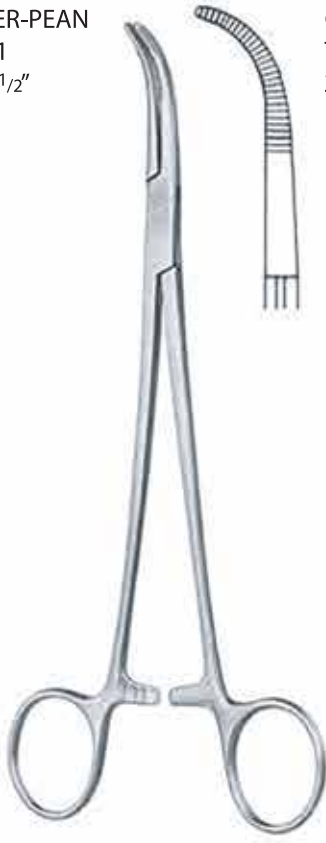

RUMEL
TS-GI-1004
18.0 cm/7"



RUMEL
TS-GI-1004
23.0 cm/9"



TREVALLI



PARAMETRIUM
24.0 cm/9 1/2"



AA 543/01



AA 543/02

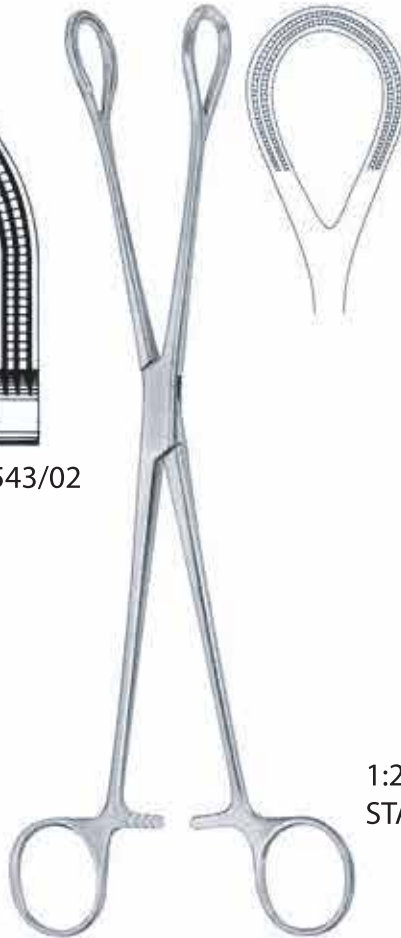

PARAMETRIUM
24.0 cm/9 1/2"



AB 060/20
20.0 cm/8"

AB 060/25
25.0 cm/10"

1:2
STANDARD

GILLIES 1:2
AB 430/15
15.0 cm/6"



DE BAKY



2.0mm
AB 862/20
20.0 cm/8"

gebogen
curved
curvas
courbes
curve



2.0mm
AB 862/24
24.0 cm/ 9 1/2"



STANDARD
AC 011/15
15.5 cm/6"



AC 091/20
20.0 cm/8"

gebogen
curved
curvas
courbes
curve

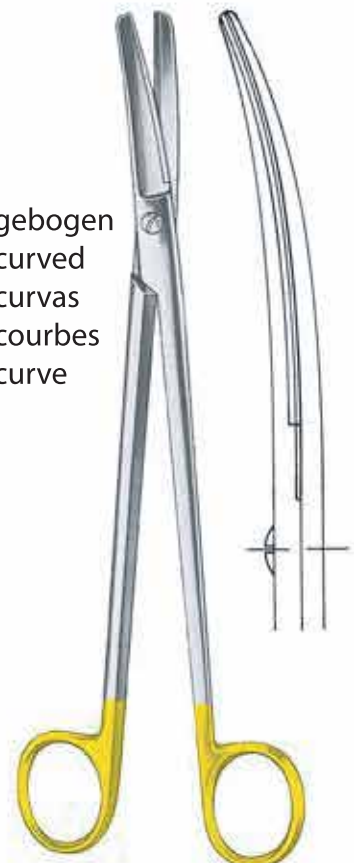

SIMS
AC 919/23
23.0 cm/9"



METZENBAUM
AC 941/20
20.0 cm/8"

METZENBAUM-DELICATE
AC 971/25
25.0 cm/10"



AD 010/04
No. 4



AE 400/16
16.0 cm/6¹/₄"

AE 400/20
20.0 cm/8"

AE 400/24
24.0 cm/9¹/₂"

MAYO-HEGAR



BOZEMANN
AE 476/24
24.0 cm/9¹/₂"



GROSS-MAIER
AF 100/27
27.0 cm/10³/₄"

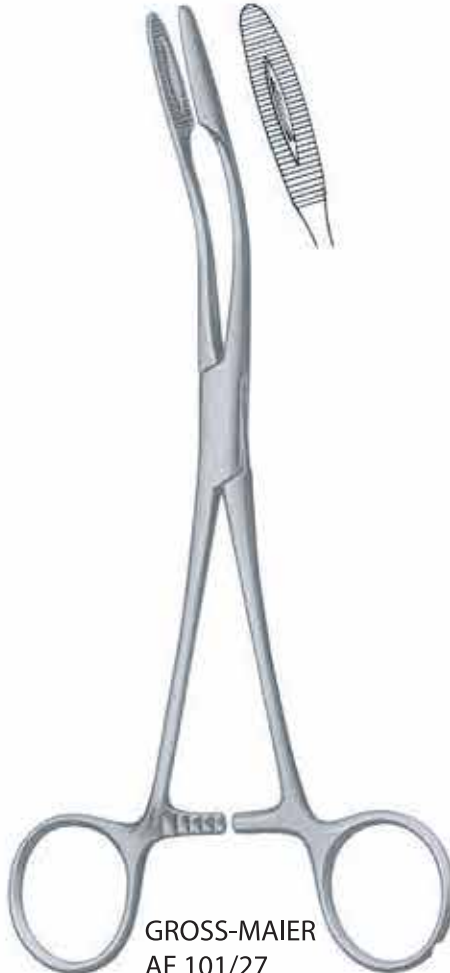

GROSS-MAIER
AF 101/27
27.0 cm/10³/₄"

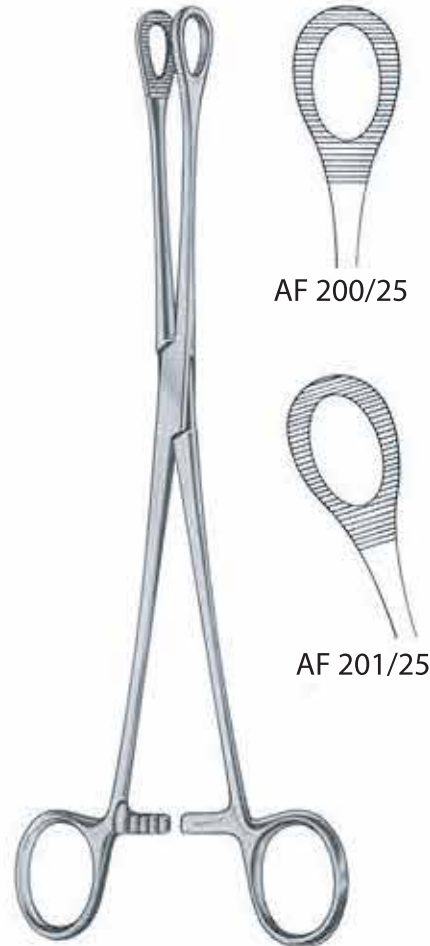

AF 200/25

AF 201/25

FOERSTER-BALLENGER
25.0 cm/10"



FRITSCH
24.0 cm / 9 1/2"
45 x 75 mm AK 254/75

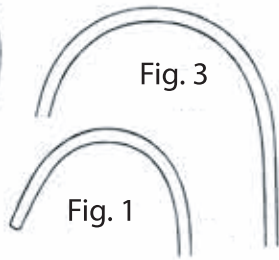

ROUX
16.5 cm/6 1/2"
Fig. 1 AK 350/01
Fig. 3 AK 350/03



33,0 cm/13"
40 mm AK 804/40



Charr./Fr.
14 AO 820/14



BREISKY
130 x 30 mm
KB 093/30



SCHRÖDER
KB 255/25
25.0 cm/10"

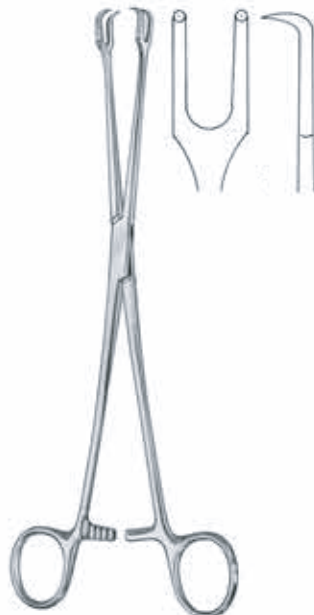

SCHRÖDER
KB 262/24
24.0 cm/9 1/2"



PRATT
KB 265/28
28.0 cm/11"

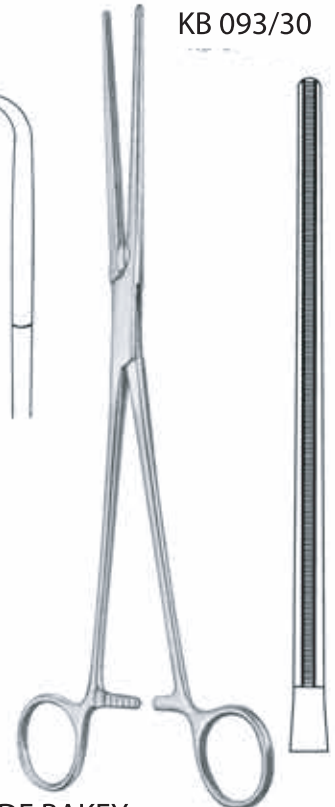

DE BAKEY
KK 486/27
27.0 cm/10 1/2"

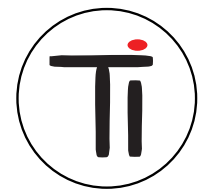

Øx h
80 x 40 mm 0.14 l KU 300/08

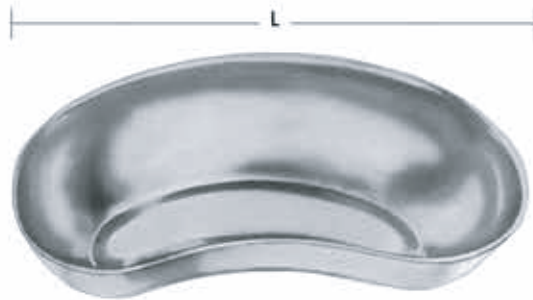

L=250 mm KU 302/25

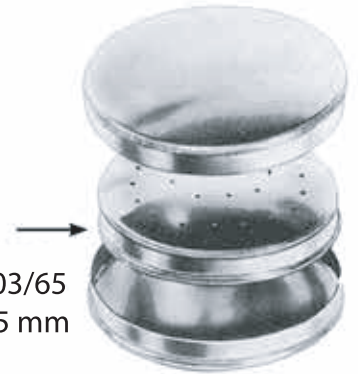

KU 303/65
Ø= 65 mm



MARTIN/BERCHTOLD
XR 803/05



XR 841/01



XR 843/04



L(mm)	B(mm)	H(mm)	
540	255	50	SK 307/05

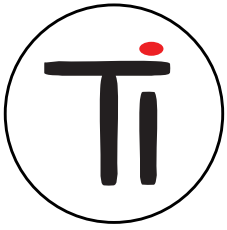

TREVALLI

SET

VAGINAL HYSTERECTOMY



TREVALLi



ROCHESTER-PEAN
AA 200/24
24.0 cm/9 1/2"

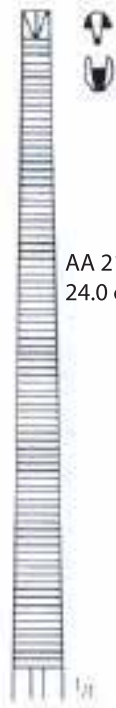

AA 210/24
24.0 cm/ 9 1/2"



OCHSNER-KOCHER 1:2
24.0 cm/9 1/2"

AA 211/16
16.0 cm/ 6 1/4"

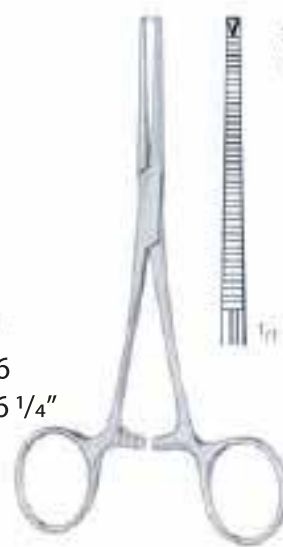

KOCHER 1:2 - DELICATE
AA 216/14
14.0 cm/5 1/2"



OVERHOLT-GEISSENDOERFER
21,0 cm/8 1/4"

AA 221/02
21.0 cm/8 1/4"

AA 223/01
27.0 cm/10 3/4"



RUMEL
23.0 cm/9"



AA 335/04

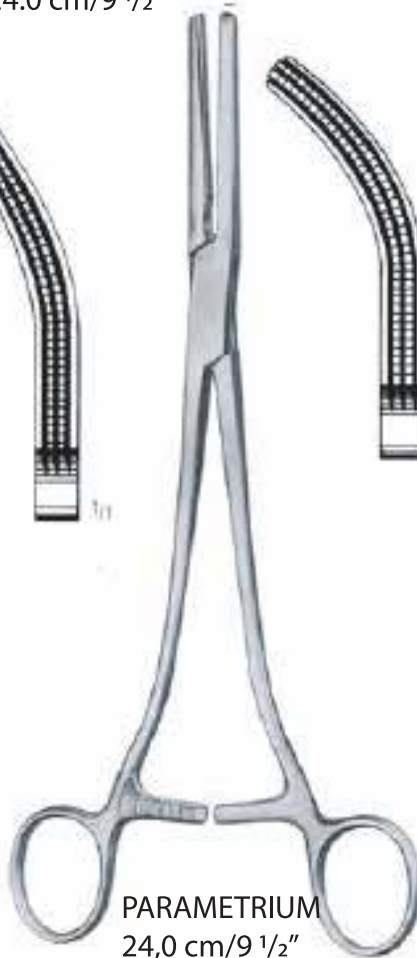

PARAMETRIUM
24,0 cm/9 1/2"



STANDARD
AB 050/20
20.0 cm/8"



1:2 STANDARD

AB 060/20
20,0 cm/8"

AB 060/25
25.0 cm/10"

VAGINAL-HYSTERECTOMY SET



STANDARD
AC 011/15
15.5 cm/6"



SIMS
AC 091/20 20,0 cm/8"
AC 091/23 23,0 cm/9"



AC 941/18
18.0 cm/7"

AC 941/23
23.0 cm/9"

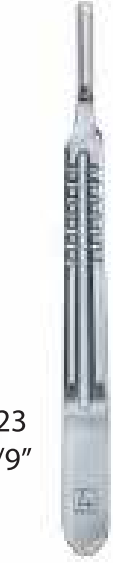

AD 010/04
No. 4



MAYO-HEGAR
AE 400/20
20.0 cm/8"



WERTHEIM
AE 487/24
24.0 cm/ 9 1/2"



GROSS-MAIER
AF 100/27
27.0 cm/ 10 3/4"



FOERSTER-BALLENGER
AF 201/25
25.0 cm/10"

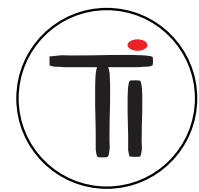

95 x 20 mm

MODELL TÜBINGEN
AK 239/28
28.0 cm/11"

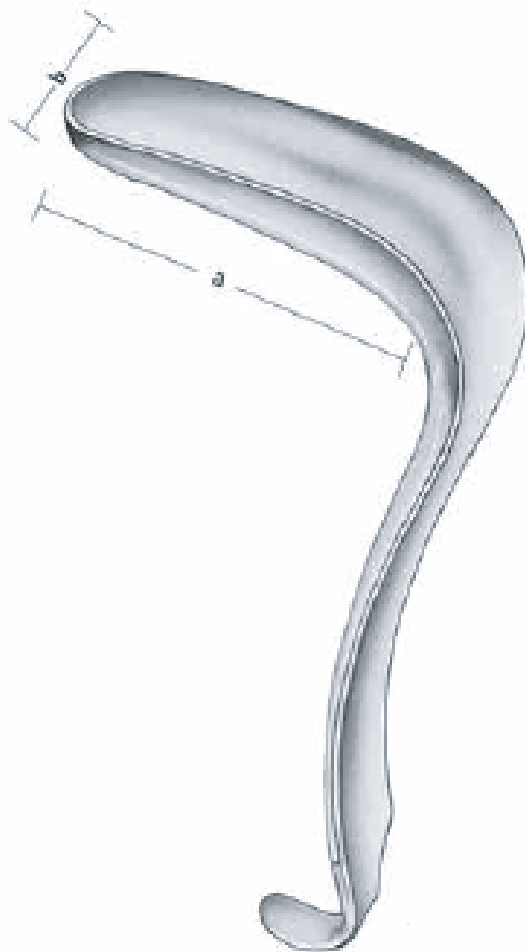

KRISTELLER

a

b

Fig. 2 110 x 30 mm KB 062/02

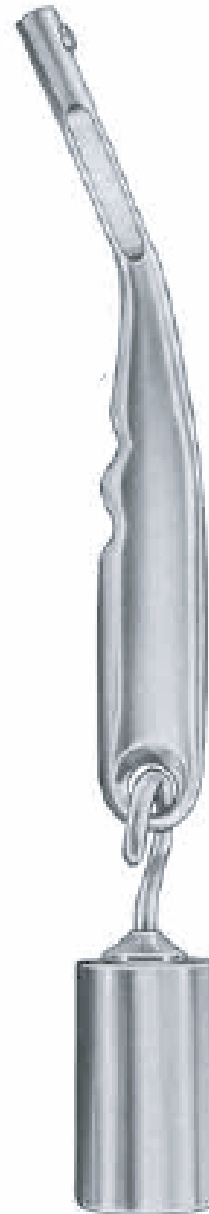

SCHERBACK

400 g = KB 078/40



KB 078/10



KB 078/11



KB 078/12



KB 078/13



KB 078/14

KB 078/05 = KB 078/10

KB 078/11

KB 078/12

KB 078/13

KB 078/14

KB 078/20

KB 078/40



BREISKY
 100 x 25 mm KB 093/25
 100 x 30 mm KB 093/30
 100 x 40 mm KB 093/40



SIMS
 KB 201/32
 32.0cm/ 12 1/2"



SCHRÖDER
 KB 255/25
 25.0 cm/10"



BOYS-ALLIS 5:6
 KD 055/15
 15.0 cm/6"

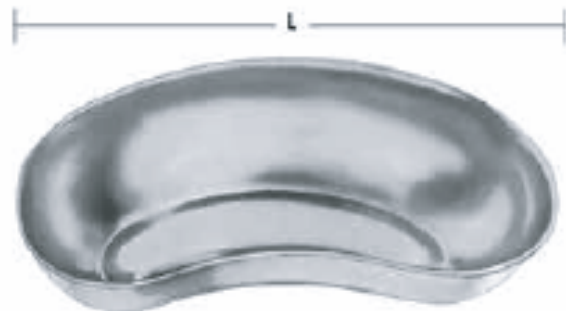

L = 250mm KU 302/25



KU 303/65

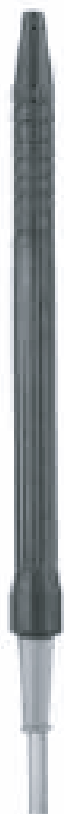

MARTIN/BERCHTOLD
XR 803/05



XR 841/01

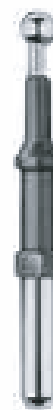

XR 843/04



L(mm)	B(mm)	H(mm)	
540	255	50	SK 307/05

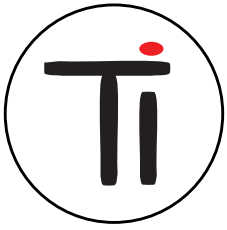

TREVALLI

SET

MAMMAPLASTY

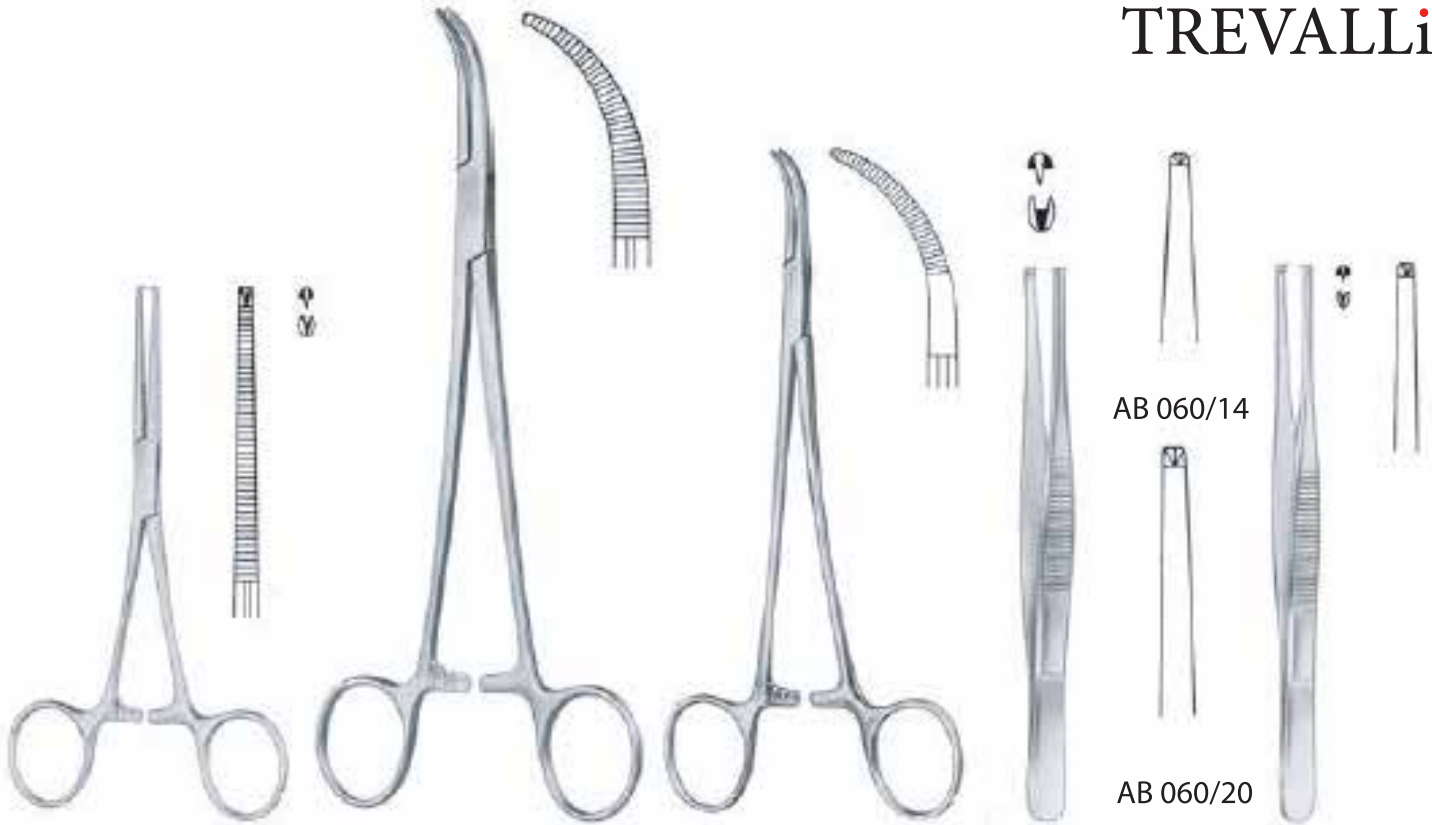
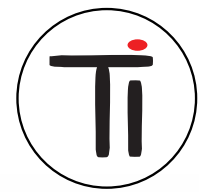

KOCHER 1:2 - DELICATE
AA 216/14
14.0 cm/5 1/2"

OVERHOLT-GEISSENDOERFER
AA 221/02
21.0 cm/8 1/4"

BABY-MIXTER
AA 348/18
18.0 cm/7"

STANDARD 1:2
20.0 cm/8"

1:2
AB 080/16
16.0 cm/6 1/4"



AB 862/16
16.0 cm/6 1/4"

AB 862/20
20.0 cm/8"



DE BAKEY

METZENBAUM-DELICATE
Fig. 1
AC 141/14
14.5 cm/5 3/4"

STANDARD
Fig. 1 curved:
AC 901/14
14.5 cm/5 3/4"

METZENBAUM
AC 941/20
20.0 cm/8"

TOENNIS-ADSON-DELICATE
AC 977/17
17.5 cm/7"



AD 010/03
No. 3



AD 010/04
No. 4



MAYOHEGAR
AE 400/20
20.0 cm/8"



CRILE-WOOD
AE 470/15
15.0cm/ 6"

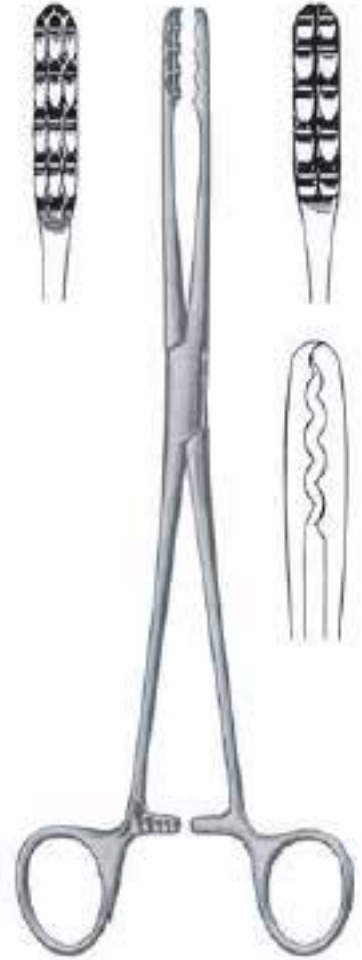

ULRICH
AF 070/27
27.0 cm/10 ³/₄"



GROSS-MAIER
AF 100/27
27.0 cm/10 ³/₄"



AK 050/03
16.0 cm/6 ¹/₄"



CUSHING
AK 100/14
14 mm
20.0 cm/8"



ROUX
16.5 cm/ 6 ¹/₂"
AK 350/00
AK 350/03

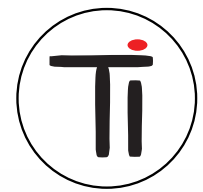

Charr./Fr.
10 AO 821/10
12 AO 821/12
14 AO 821/14



SCHRÖDER
KB 262/24
24.0 cm/9 1/2"



KU 303/65



L = 250 mm KU 302/25



MARTIN / BERCHTHOLD
300 cm XR 830/03



XR 890/20C
20.0 cm/8"



L(mm)	B(mm)	H(mm)
485	255	70

SK 305/07

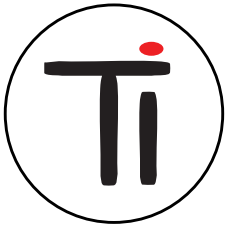

TREVALLI

SET

HYSTEROSCOPY ENDOMETRIAL DIAGNOSTIC



TREVALLI



GROSS-MAIER
AF 100/27
27.0 cm/10 3/4"



GROSS-MAIER
AF 101/27
27.0 cm/ 10 3/4"



KRISTELLER
Fig. 2
KB 064/02 = KB 062/02 + KB 063/02
110 x 30 mm 115 x 26 mm



AO 912/00

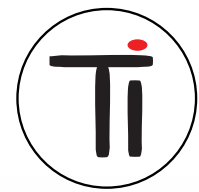

HEGAR

- | | |
|------------------|-------------------|
| 1.0 mm KB 100/02 | 6.5 mm KB 100/13 |
| 1.5 mm KB 100/03 | 7.0 mm KB 100/14 |
| 2.0 mm KB 100/04 | 7.5 mm KB 100/15 |
| 2.5 mm KB 100/05 | 8.0 mm KB 100/16 |
| 3.0 mm KB 100/06 | 8.5 mm KB 100/17 |
| 3.5 mm KB 100/07 | 9.0 mm KB 100/18 |
| 4.0 mm KB 100/08 | 9.5 mm KB 100/19 |
| 4.5 mm KB 100/09 | 10.0 mm KB 100/20 |
| 5.0 mm KB 100/10 | 10.5 mm KB 100/21 |
| 5.5 mm KB 100/11 | 11.0 mm KB 100/22 |
| 6.0 mm KB 100/12 | 11.5 mm KB 100/23 |



SCHRÖDER
KB 255/25
25.0 cm/10"



SIMS
KB 201/32
32.0 cm/12 1/2"



RECAMIER / SIMS
31.0 cm/12 1/4"

- Fig. 0 6.0 mm KB 500/00
Fig. 1 7.0 mm KB 500/01
Fig. 3 9.0 mm KB 500/03
Fig. 4 11.0 mm KB 500/04



Ø x h
116 x 50 mm
0.35 | KU 300/11



KU 303/65



L(mm)	B(mm)	H(mm)	
485	255	70	SK 305/07

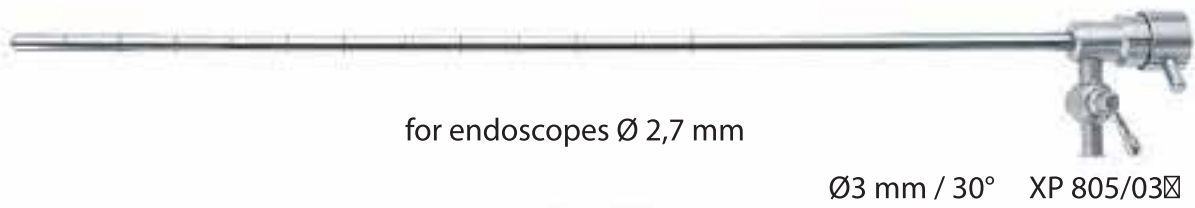
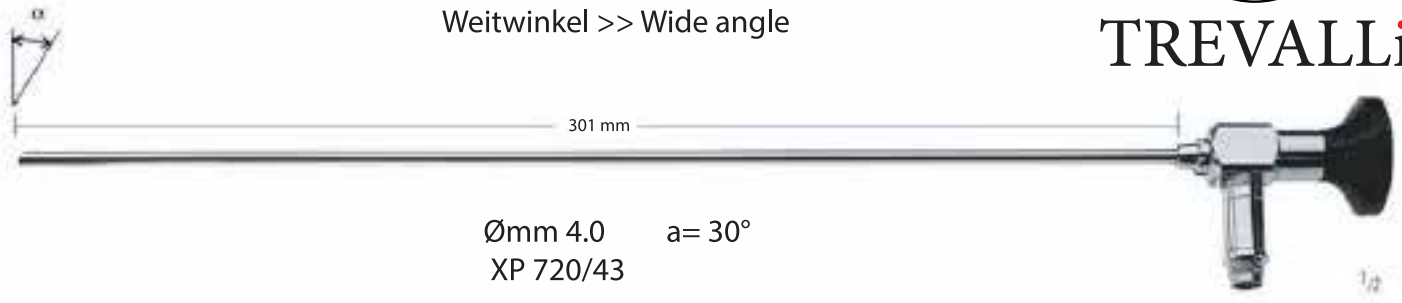

XT 035/18 3.5mm 180cm

XT 100/01



STORZ



XT 100/11

STORZ/WINTER + IBE
OLYMPUS/STRYKER

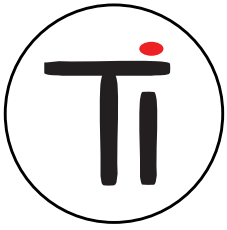

TREVALLI

SET

CONISATION GYN

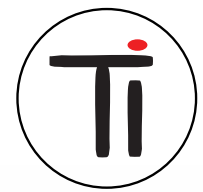

OCHSNER-KOCHER 1:2
AA 210/24
24.0 cm/9 1/2"



STANDARD
AB 050/20
20,0 cm/8"



STANDARD 1:2
AB 060/20
20,0 cm/8"



SIMS
AC 090/20
20,0 cm/8"



SIMS
AC 091/20
20,0 cm/8"



AD 010/03
No. 3



AD 020/13
No. 3L



WERTHEIM
AE 487/24
24,0 cm/9 1/2"



GROSS-MAIER
AF 100/27
27,0 cm/10 3/4"



GROSS-MAIER
AF 101/27
27,0 cm/10 3/4"



KB 078/11



KB 078/12



KRISTELLER

Fig. 2

KB 064/02 = KB 062/02 + KB 063/02
110 x 30 mm 115 x 26 mm



BREISKY
130 x 25 mm KB 093/25
130 x 30 mm KB 093/30
130 x 35 mm KB 093/35



KB 078/20



SCHERBACK
400 g = KB 078/40



HEGAR

- 2,0 mm KB 100/04
- 2,5 mm KB 100/05
- 3,0 mm KB 100/06
- 3,5 mm KB 100/07
- 4,0 mm KB 100/08
- 4,5 mm KB 100/09
- 5,0 mm KB 100/10
- 5,5 mm KB 100/11
- 6,0 mm KB 100/12
- 6,5 mm KB 100/13
- 7,0 mm KB 100/14
- 7,5 mm KB 100/15
- 8,0 mm KB 100/16
- 8,5 mm KB 100/17
- 9,0 mm KB 100/18
- 9,5 mm KB 100/19
- 10,0 mm KB 100/20
- 10,5 mm KB 100/21
- 11,0 mm KB 100/22
- 11,5 mm KB 100/23



SIMS
KB 200/32
32,0 cm/12 1/2"



SCHRÖDER
KB 255/25
25,0 cm/10"

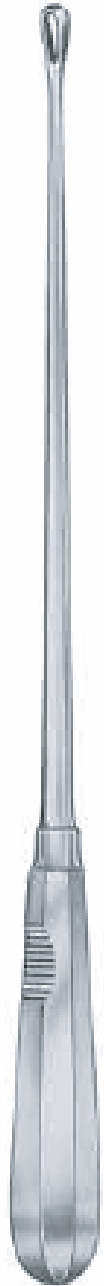

RECAMIER / SIMS
31.0 cm/12 1/4"



Ø x h
116 x 50 mm 0,35 | KU 300/11



L = 250 mm KU 302/25

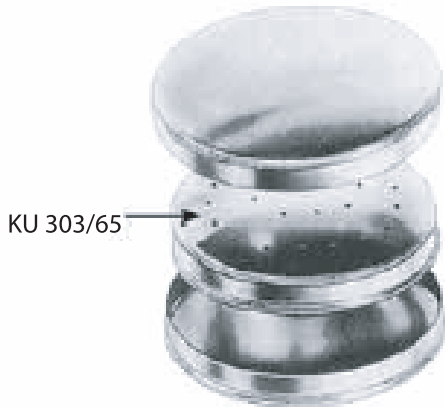

KU 303/65

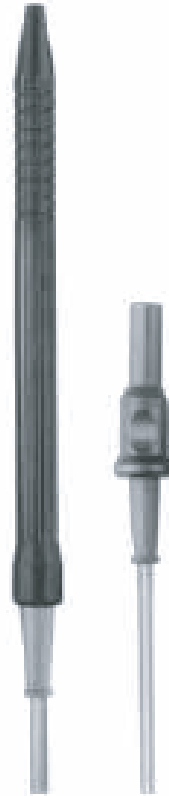

MARTIN / BERCHTHOLD
XR 803/05



XR 841/09



XR 841/10

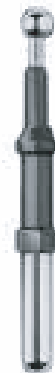

XR 843/04



XR 843/05

- Fig. 1 7.0 mm KB 500/01
- Fig. 2 8.0 mm KB 500/02
- Fig. 5 12.0 mm KB 500/05
- Fig. 6 14.0 mm KB 500/06



L(mm) B(mm) H(mm)\
485 255 70 SK 305/07

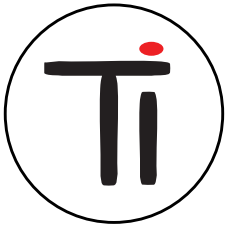

TREVALLI

SET

CAESAREAN SECTION



TREVALLi



ROCHESTER-PEAN
AA 200/24
24.0 cm/9 1/2"



OCHSNER-KOCHER 1:2
AA 210/24
24.0 cm/9 1/2"



KOCHER 1:2 - DELICATE
AA 216/14
14.0 cm/5 1/2"



OVERHOLT-GEISSENDOERFER
AA 221/02
21.0 cm/8 1/4"



AA 558/25
25.0 cm/10"



STANDARD
AB 050/20
20.0 cm/8"



STANDARD 1:2



AB 060/20
20.0 cm/8"



AB 060/25
25.0 cm/10"



1:2
AB 080/14
14.5 cm/5 3/4"



AA 558/25
25.0 cm/10"

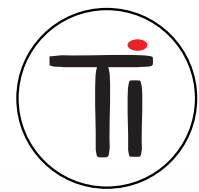

STANDARD
AC 011/15
15.5 cm/6"



SIMS
AC 091/20
20.0 cm/8"



SIMS
AC 091/20
20.0 cm/8"



METZENBAUM
AC 941/23
23.0 cm/9"



AD 010/04
No. 4



MAYO-HEGAR



AE 400/20
20.0 cm/8"



AE 400/24
24.0 cm/9 1/2"



LCRILE-WOOD
AE 470/15
15.0 cm/6"



GROSS-MAIER
AF 100/27
27.0 cm/10 3/4"



GROSS-MAIER
AF 101/27
27.0 cm/10 3/4"

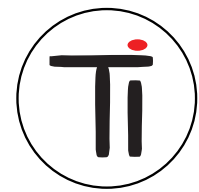

FOERSTER-BALLENGER
AF 201/25
25.0 cm/10"



FRITSCH
AK 254/75
45 x 75 mm
24.0 cm / 9 1/2"



ROUX
16.5 cm/6 1/2"
Fig. 2 AK 350/02



RECAMIER / SIMS
KB 500/02
Fig. 2 8.0 mm
31.0 cm/12 1/4"



SIMPSON
KB 734/30
30.0 cm/12"



Lorem ipsum



L(mm)	B(mm)	H(mm)
540	255	50

SK 307/05

bipolar



C=1.0 mm

XR 896/20C
20.0 cm/8"

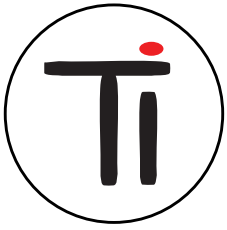

TREVALLI

SET
PARTUS

PARTUS SET

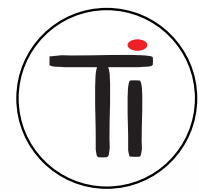

TREVALLI

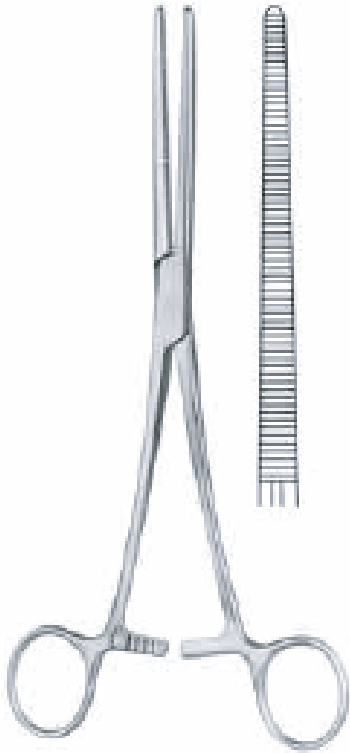

ROCHESTER-PEAN
AA 200/18
18.0 cm/7"

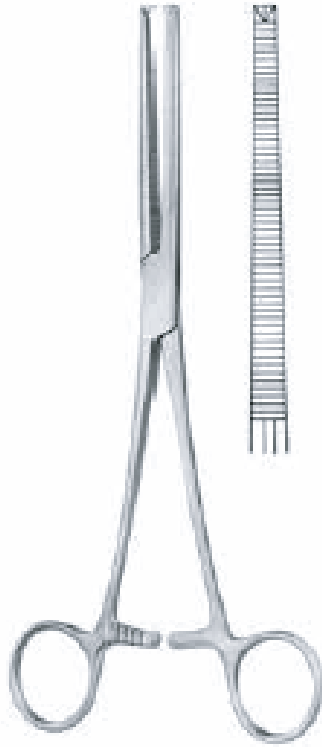

OCHSNER-KOCHER 1:2
AA 210/18
18.0 cm/7"

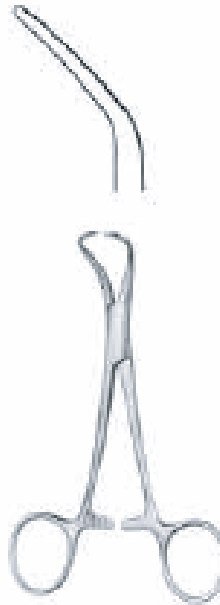

BACKHAUS
AA 751/08
8.0 cm/3"



STANDARD
AB 050/14
14.5 cm/5 3/4"



1:2
STANDARD
AB 060/14
14.5 cm/5 3/4"



BRAUN-STADLER
AC 351/14
14.0 cm/5 1/2"

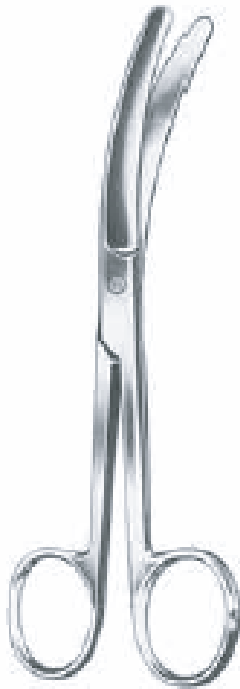

BUSCH
AC 365/13
13.0 cm/5"



AD 010/03
No. 3



Fig.10
AD 075/10

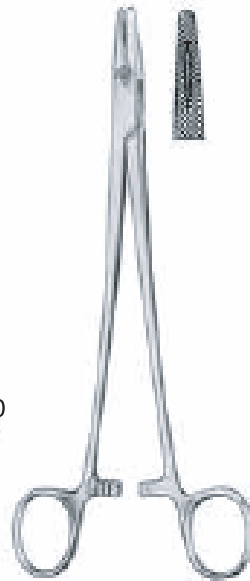

MAYO-HEGAR
AE 100/14
14.0 cm/ 5 1/2"



PINARD
AR 310/02

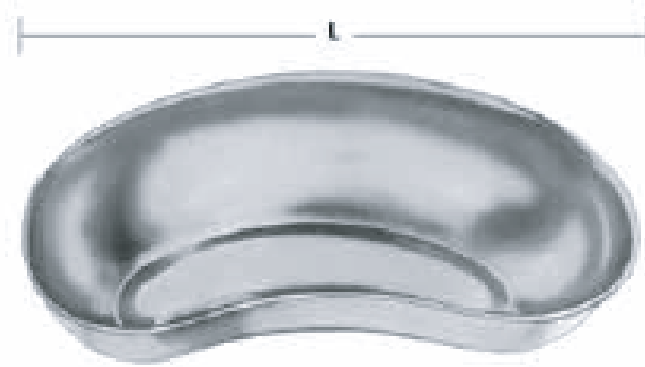
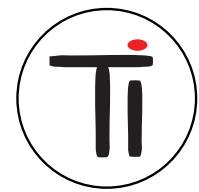

L = 250 mm

KU 302/25

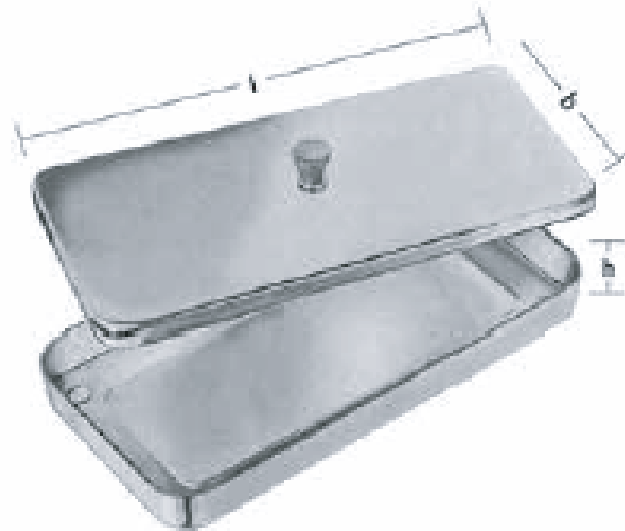

l x b x h

20.0 x 10.0 x 5.0 cm KU 312/20



L(mm)
255

B(mm)
245

H(mm)
50

SK 105/05

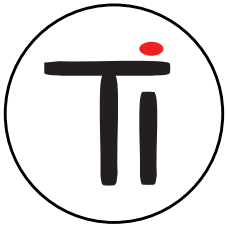

TREVALLI

SET

DELIVERY



OCHSNER-KOCHER 1:2
AA 210/14
14.0 cm/5 1/2"



BUSCH
AC 365/16
16.0 cm/6 1/4"

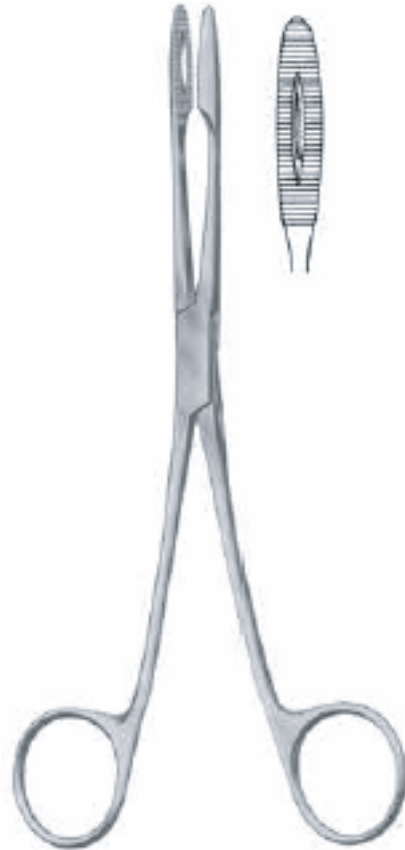

GROSS-MAIER
AF 102/22
22.0 cm/8 3/4"

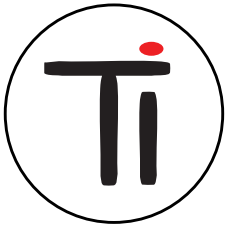

TREVALLI

SET

DILATATION / CURETTAGE



TREVALLI



STANDARD
AB 050/20
20.0 cm/8"



SIMS
AC 091/20
20.0 cm/8"

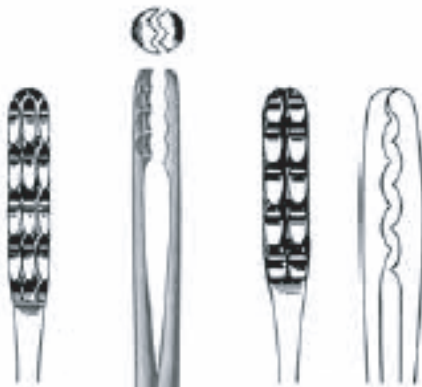

ULRICH
AF 070/27
27.0 cm/10³/₄"

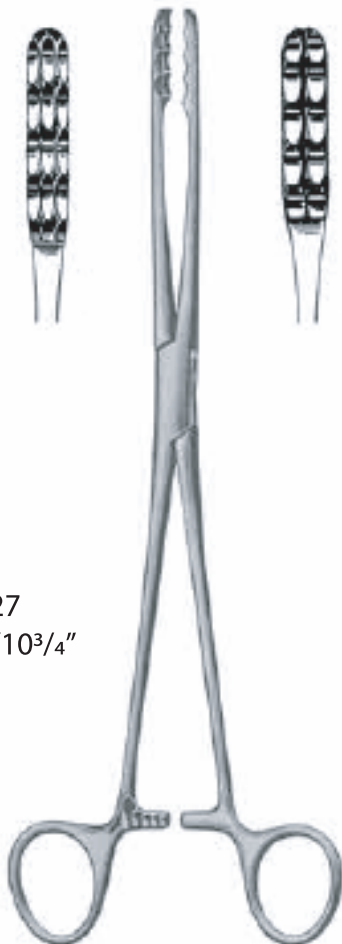

GROSS-MAIER
AF 101/27
27.0 cm/10³/₄"

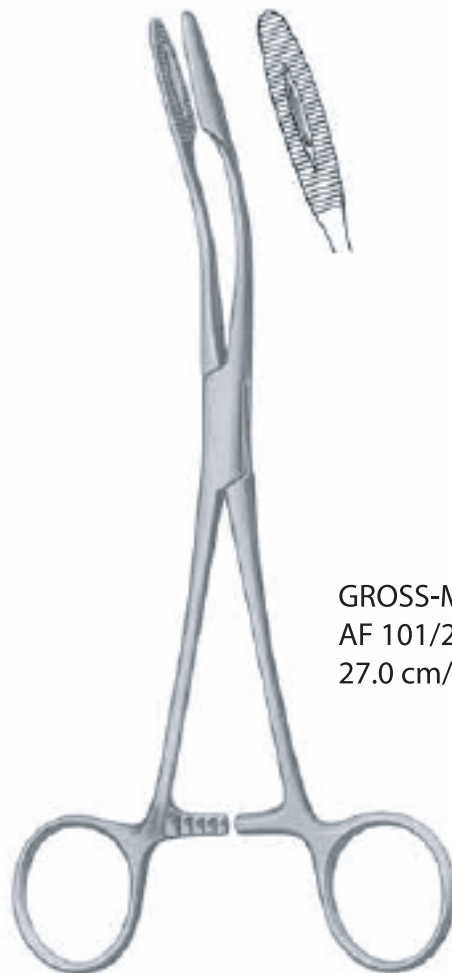



Absaugung am oberen Blatt
Suction tube on upper blade
Tubo de succión en la valva superior
Canule d'aspiration à la lame supérieure
Canula d'aspirazione alla valva superiore

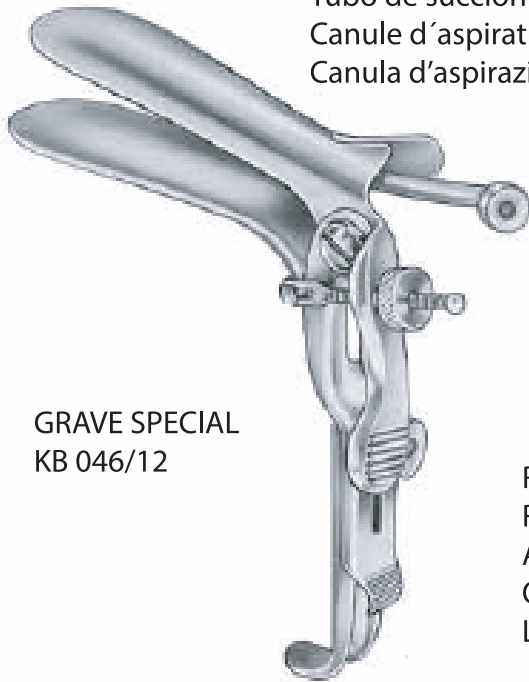

GRAVE SPECIAL
KB 046/12

Rechte Seite offen
Right side open
Apertura lateral derecha
Ouverture à droite
Lato destro aperto

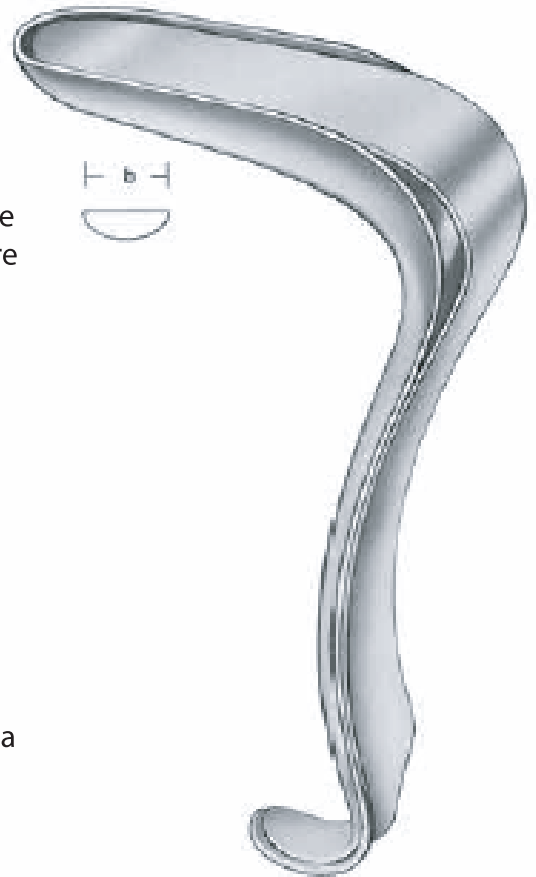

KRISTELLER
Fig. 3
KB 055/03 = KB 053/03 + KB 054/03
90 x 36 mm
100 x 32 mm

SCHRÖDER
KB 255/25
25.0 cm/10"



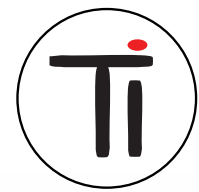

RECAMIER / SIMS
31.0 cm/12 1/4"
Fig. 4 11.0 mm KB 500/04



RECAMIER / SIMS
31,0 cm/12 1/4"
Fig. 6 14,0 mm KB 550/06
Fig. 8 16,0 mm KB 550/08
Fig. 9 19,0 mm KB 550/09
Fig. 12 23,0 mm KB 550/12



WINTER
28,0 cm/11"
Fig. 3 KB 781/03



Ø x h
116 x 50 mm 0.35 I KU 300/11



L(mm)	B(mm)	H(mm)	
485	255	50	SK 305/05

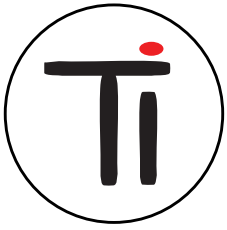

TREVALLI

SET

HYSTEROSCOPY BASIC

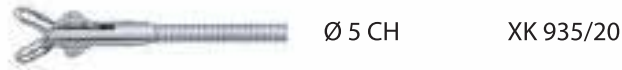
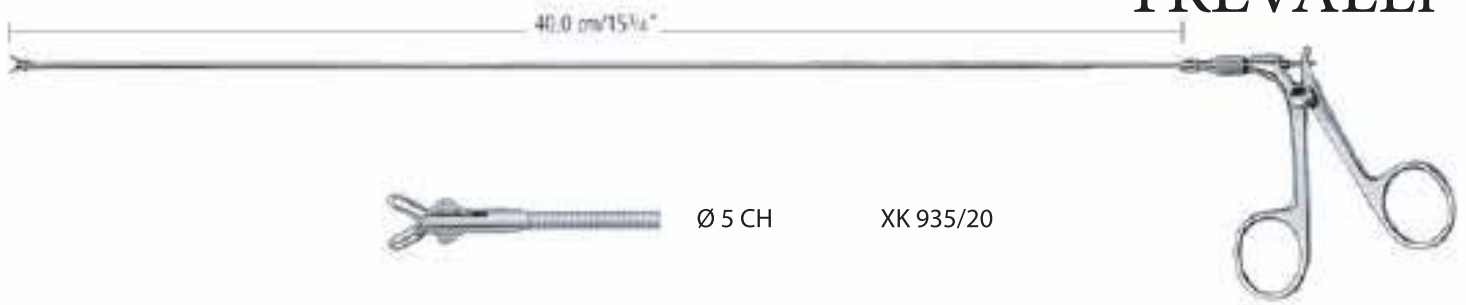

Ø 5 CH XK 935/20

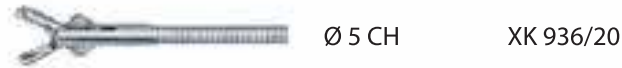

Ø 5 CH XK 936/20

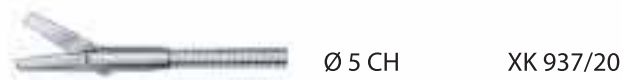

Ø 5 CH XK 937/20

>> Resektoskop mit Dauerspülschaft, drehbar
>> Resectoscope with continuous flow shaft, rotating

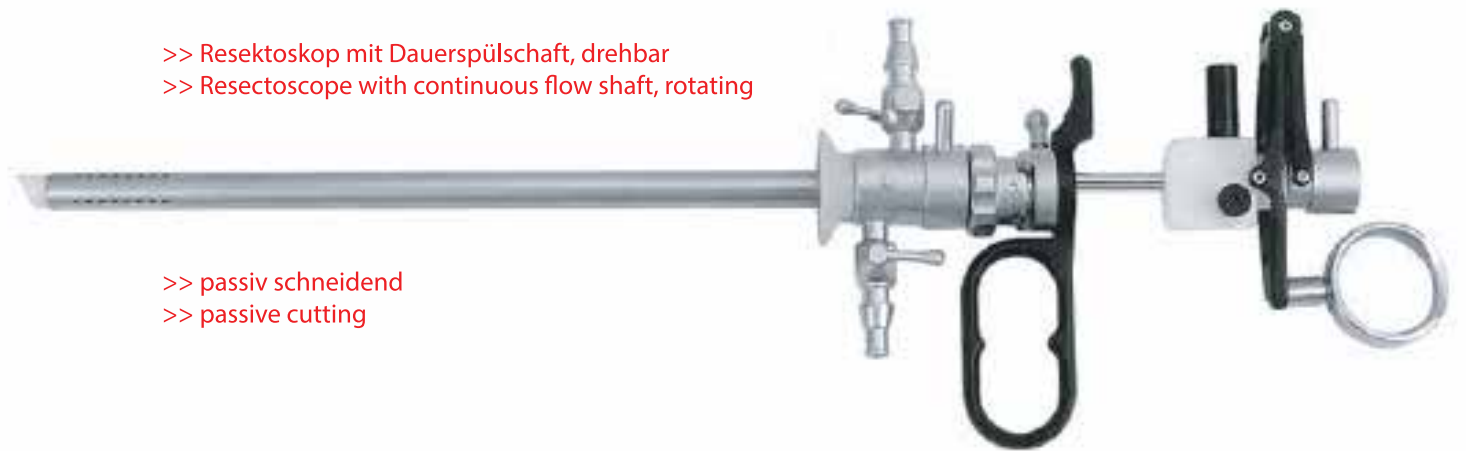

>> passiv schneidend
>> passive cutting

Ø 27 CH XM 500/00
komplett
complete
completo
complet
completo

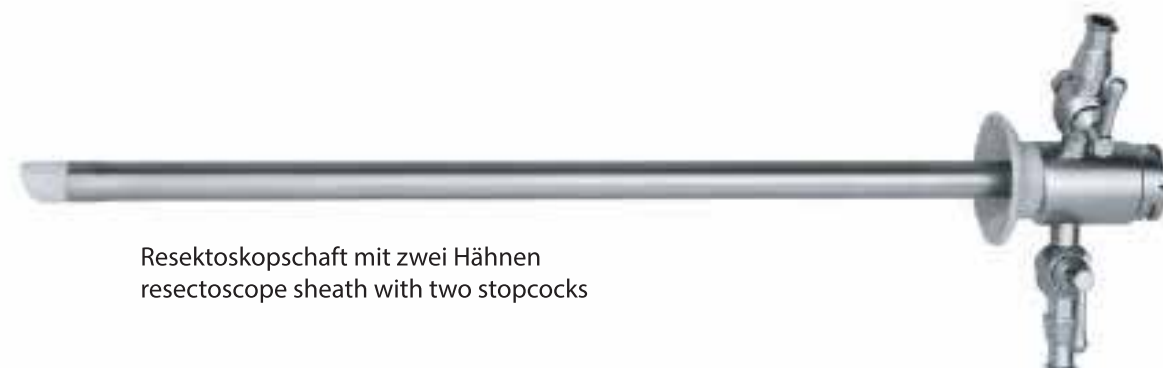

Resektoskopschaft mit zwei Hähnen
resectoscope sheath with two stopcocks

Ø 24 CH XM 501/25

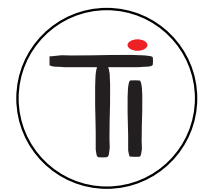

Ø 24 CH Schneide- und Koagulationselektroden
 Ø 24 CH Cutting and coagulation electrodes

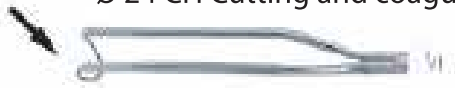

XM 510/02

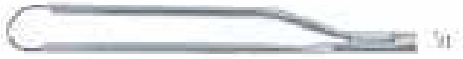

XM 510/04



3 mm

XM 512/03

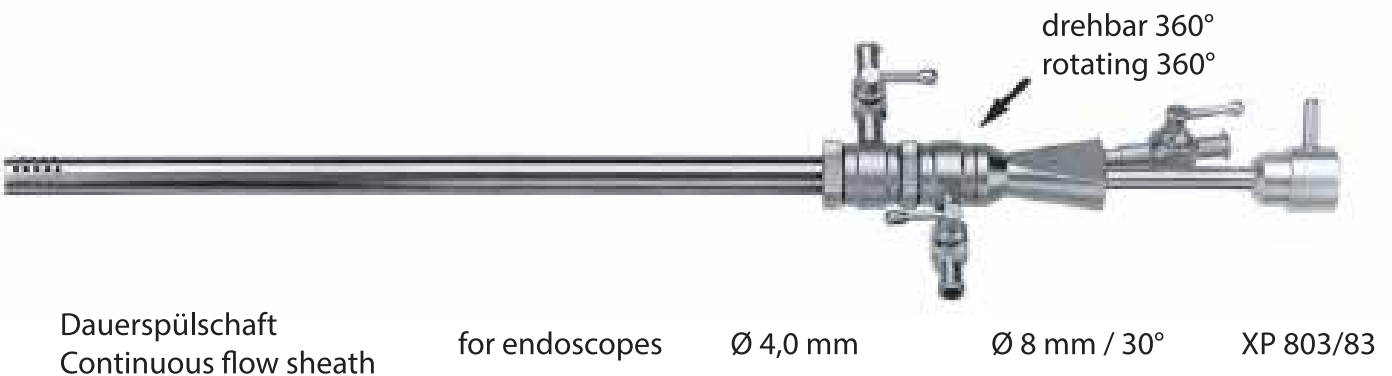
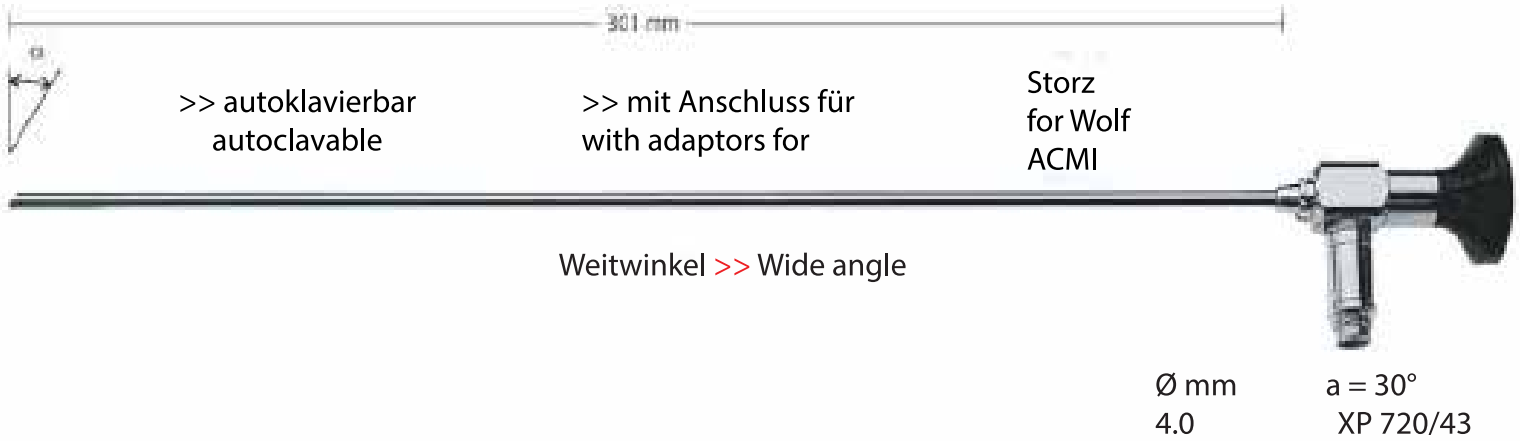



L(mm)	B(mm)	H(mm)	
540	255	50	SK 307/05



L(mm)	B(mm)	H(mm)	
460	80	52	SU 515/46

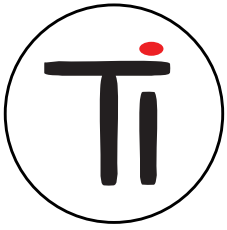

TREVALLI

SET

NEPHRECTOMY



TREVALLi

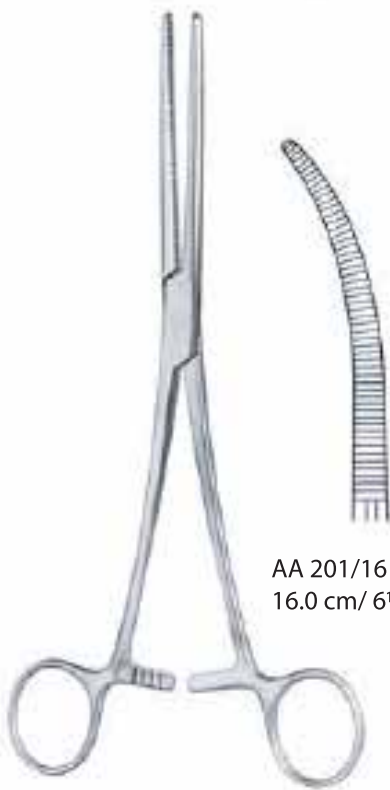

AA 201/16
16.0 cm/ 6¹/₄"

ROCHESTER-PEAN



AA 201/20
20.0 cm/ 8"



OCHSNER-KOCHER 1:2
AA 210/16
16.0 cm/ 6¹/₄"



MIXTER
AA 345/19
19.0 cm/7¹/₂"



LAHEY
AA 401/23
23.0 cm/ 9"



GUYON
AA 409/24
24.0 cm/9¹/₂"



HERRICK
AA 417/23
23.0 cm/9"

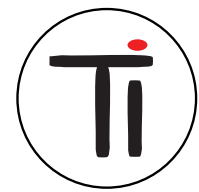

WERTHEIM-CULLEN
AA 529/21
21.5 cm/8 1/2"



BACKHAUS
AA 751/13
13.0 cm/5"



STANDARD
AB 050/25
25.0 cm/10"



STANDARD
1:2
AB 060/25
25.0 cm/10"



POTTS-SMITH
AB 200/25
25.0 cm/10"



POTTS-SMITH 1:2
AB 210/25
25.0 cm/10"



MAYO
AC 070/23
23.0 cm/9"



MAYO
AC 071/23
23.0 cm/9"



AD 020/13
No. 3L



MAYO-HEGAR
AE 100/18
18.0 cm/7"



MASSON
AE 130/27
27.0 cm/10³/₄"



FOERSTER-BALLENGER
AF 200/25
25.0 cm/10"



RICHARDSON (KELLY)
24.0 cm/ 9¹/₂"



AK 247/04
52 X 22 mm



AK 247/05
65 X 50 mm



KA 681/17



KA 683/17

DOYEN 17.0 cm/ 6 ³/₄"



ALEXANDER
KA 689/20
20,0 cm/8"



SEMB
KA 762/19
19.0 cm/7 ¹/₂"



TREVALLi



STILLE-LUER
KA 853/22
22.0 cm / 8³/₄"



LISTON-KEY
(TUDOR-EDWARDS)
KA 892/27
27.0 cm / 10¹/₂"



ALLIS 5:6
KD 055/25
25.0 cm / 10"



BABCOCK
KD 111/20
20.0 cm / 8"



L(mm)	B(mm)	H(mm)	SK 305/07
485	255	70	

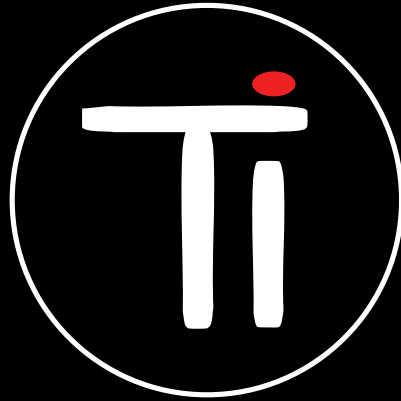

TREVALLi

tomorros solutions . . . today!

 083 555 8643

@ trevalli@mweb.co.za

 3 Oldham Place,
Pietermaritzburg

 Postnet suite #A02,
Private Bag X8,
Cascades, 3202

